

Temperature sensor suitable for measurement primarily in heat-treating furnaces, boiler houses, etc. This sensor has ceramic protection tube.

Specification

Temperature range / sensing element		
-40÷1200°C	K	class 2
0÷1600°C	S, R	class 2
600÷1800°C	B	class 3
Sheath		
– holding tube material: steel 1.4841, \varnothing 22mm		
– ceramic tube: mullite 610 or corundum 799, \varnothing 15mm		
– length L [mm]: 300÷2000		
Thermocouple wire diameter		
– \varnothing 2mm for K		
– \varnothing 0,35mm or \varnothing 0,5mm for R, S, B		
Connection head		
–AA, IP53, -40÷100 °C		

Other parameters acc. to requirements

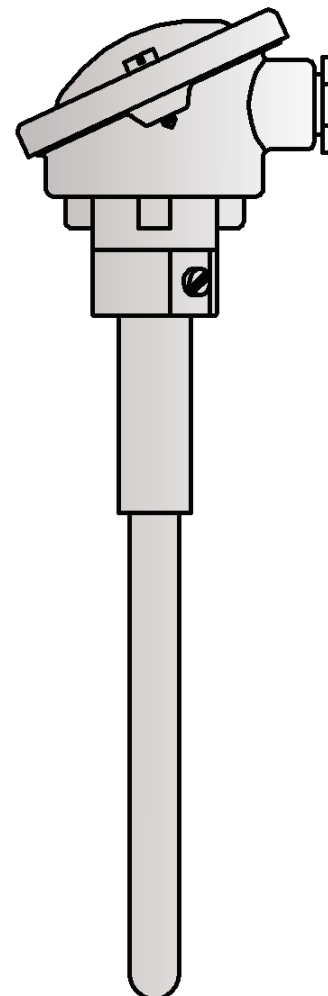

Options

Temperature transmitter application

Temperature transmitter with standard 4÷20mA, 0÷10V output signals and with the HART or PROFIBUS communication protocols can be mounted in the connection head. Transmitter installation is carried out in the high cover connection head.

Non-standard design

Immersion length, shape and material of the sheath, connection head type and the measuring insert parameters can be customized per client request.

Calibrations performed by Limatherm Sensor Sp. z o.o. are confirmed with the Calibration Certificate of the Accredited Laboratory for Temperature Measurements.

Thermocouple hot junction types

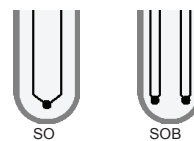
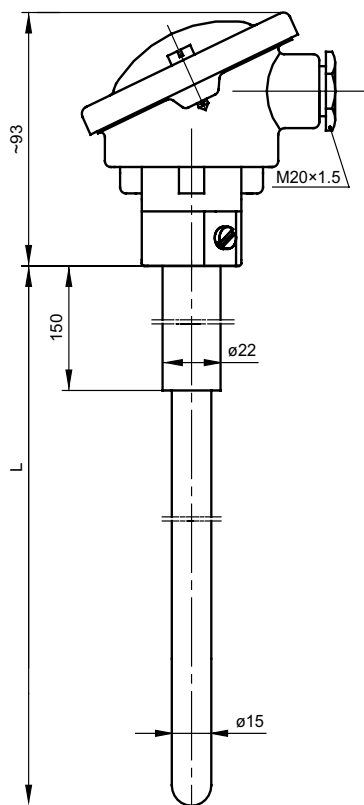

Standard length

Immersion length L [mm]
500
710
1000
1400
2000

Sheat material	Wire diameter [mm]	Thermocouple type	Max. operating temperature [°C]
mullite 610	0,35	R, S	1200
mullite 610	0,5	R, S	1400
corundum 799	0,35	R, S	1500
corundum 799	0,5	R, S	1600
corundum 799	0,35	B	1600
corundum 799	0,5	B	1800
mullite 610	2	K	1200

Tolerance for thermocouple classes acc. to PN-EN 60584

Thermocouple type	Class 1		Class 2	
	Range of application [°C]	Tolerance [°C]	Range of application [°C]	Tolerance [°C]
K NiCr-NiAl	from -40 to +375 from +375 to +1000	±1,5 ±0,004 t	from -40 to +333 from +333 to +1200	±2,5 ±0,0075 t
R PtRh13-Pt	from 0 to +1100 from +1100 to +1600	±1 ±(1 + 0,003 (t - 1100))	from 0 to +600 from +600 to +1600	±1,5 ±0,0025 t
S PtRh10-Pt				
B PtRh30-PtRh6	–	–	from +600 to +1700	±0,0025 t

|t| - absolute value of temperature

Connection head types

Connection head type AA in standard.

Possibility to mount the connection head of different type.

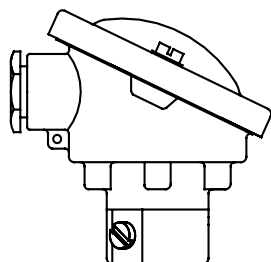

AA

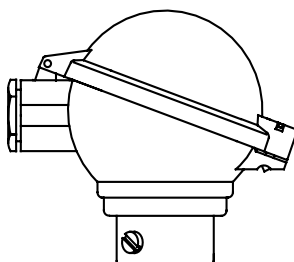

DA

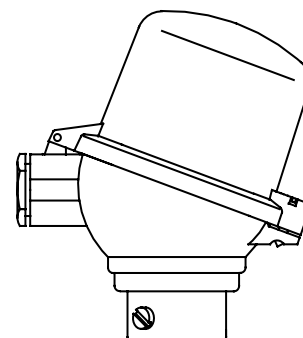

DAW

Connection schemes

TC (thermocouple)

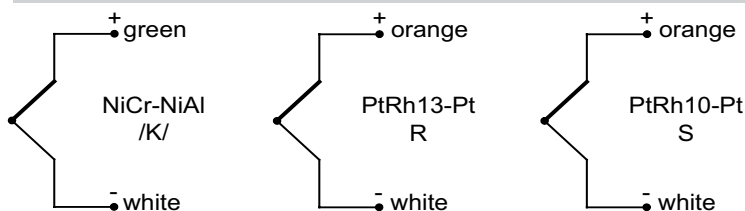

In double sensors one of thermocouples is additionally marked out.

Transmitters

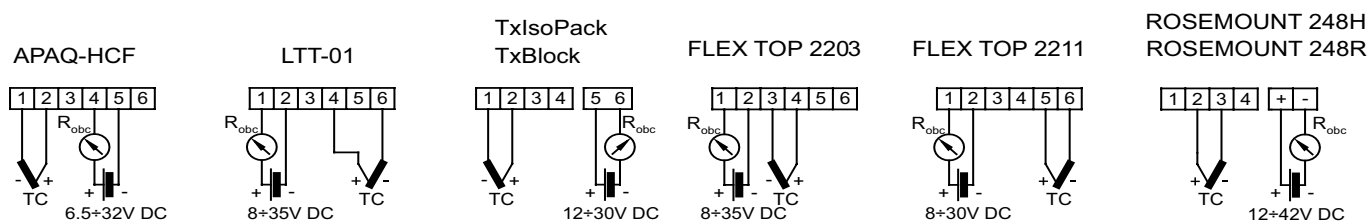

Product code

		Sensor version	
	no designation	single	
1	<input type="text"/>	2	double
	AP	with transmitter	
		Sensing element	
	B	thermocouple PtRh30-PtRh6	
	S	thermocouple PtRh10-Pt	
	R	thermocouple PtRh13-Pt	
2	<input type="text"/>	K	thermocouple NiCr-NiAl
		Ceramic sheat material	
	610	mulit 610	
3	<input type="text"/>	799	korund 799
		Thermowell length	
	500	500mm	
	710	710mm	
	1000	1000mm	
	1400	1400mm	
	2000	2000mm	
4	<input type="text"/>	other parameters acc. to requirements	
		Accuracy	
	1 or 2	for thermocouple (K, S, R)	
5	<input type="text"/>	2 lub 3	for thermocouple (B)

		Platinum wire diameter	
6	□	0,35	ø0,35mm
		0,5	ø0,5mm
		Transmitter type (optionally)	
7	□	Tx	head mounted transmitter TxBlock
			other parameters acc. to requirements
		Temperature range of transmitter	
8	□	(0÷1200°C)	transmitter configured for temperature range 0÷1200°C
			other parameters acc. to requirements

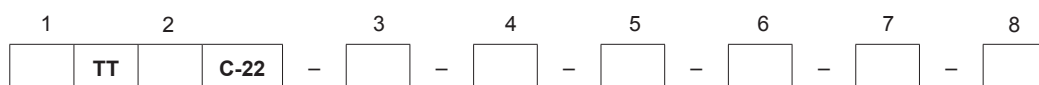

Ordering example: **2TTBC-22-799-800-2-0,5** double sensor with thermocouple PtRh30-PtRh6 /B/, class 2, platinum wire diameter 0,5 mm, ceramic sheath corundum 799, diameter 15 mm, length L=800 mm